



Signature
by VingCard®

Signature
by VingCard®

Get More with
Contact Less

Design Your Security



The company VingCard Elsafe

Since revolutionizing the hospitality industry in 1979 with hotel security solutions, VingCard Elsafe has continued to lead the market by continuously introducing innovations to the industry. VingCard Elsafe is dedicated towards providing electronic security solutions to the hospitality industry and facilities where people sleep away from home, and is recognized as the established worldwide leader within the industry.

We are where you are. With our sales force, covering all corners of the world, we have secured thousands of properties and millions of rooms. VingCard Elsafe is your true global security partner, dedicated to offer you advanced security solutions and peace of mind for both hospitality providers and their guests.

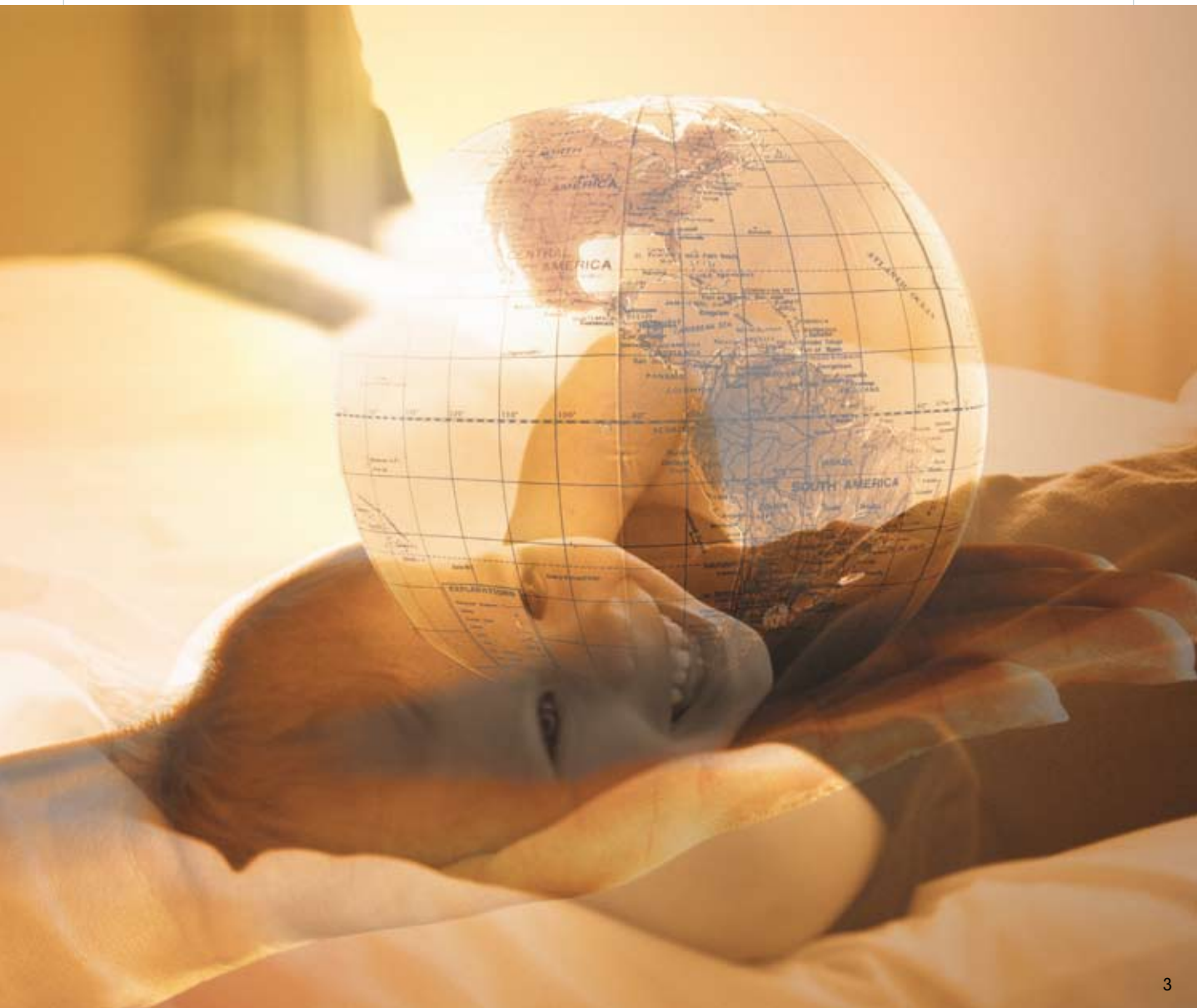

Architecture

Interior Design

Flexibility

Contents

THE COMPANY VINGCARD ELSAFE	3
BEHIND THE SIGNATURE DEVELOPMENT	5
» Design your security with Signature Series by VingCard	
» Research, Human Factors, Ergonomics & Ease of Use	
» Design & Flexibility	
» Reliability & Security	
» Functionality	
SIGNATURE BY VINGCARD	10
» Signature Trend by VingCard	
» Signature Décor by VingCard	
» Features	
» Signature Standard Range - Bezels & Handles	
SIGNATURE RFID BY VINGCARD	12
» RFID, contact less technology	
» RFID carriers	
» Benefits & Features	
» Anti-Cloning Technology	
» Quick path from standard Signature to RFID reader technology	
OPTIONAL DESIGNERS' COLLECTION	16
» Designers	
» Design Continuity	
SIGNATURE BY VINGCARD - STANDARD RANGE	24
» Finishes & Dimensions	
SIGNATURE RFID BY VINGCARD	24
» Colors & Dimensions	
LOCK SPECIFICATIONS & OPTIONS	25
» Lockcases	
» Automatic Deadbolt option	
» Emergency Cylinder option	
» Battery Cover options	
SYSTEM & SOFTWARE	26



Behind the Signature Development

Design your security with Signature Series by VingCard

Worldwide research in the hospitality industry with Hoteliers, Architects, Interior Designers, Security Experts and Guests from around the world shows that there is an increasing trend in the industry to blend electronic locks into the hotel environment using design and ease of use as the key elements.

VingCard partnered with Bresslergroup which, with 70 major international design awards and over 70 patents, is one of the most famous industrial design firms. Bresslergroup's experience in the hospitality industry, the human factors/ergonomics, and disability discrimination regulations, were key aspects in this development process. Their knowledge drove the design recommendations leading to truly user-centric solutions.

We proudly introduce Signature Series by VingCard. An electronic locking system especially developed with design and ease of use in mind, that perfectly blends into any hotel environment and provides the latest RFID (Radio Frequency Identification) contact less technology.

In partnership with **BRESSLER**group



design your security
design your security



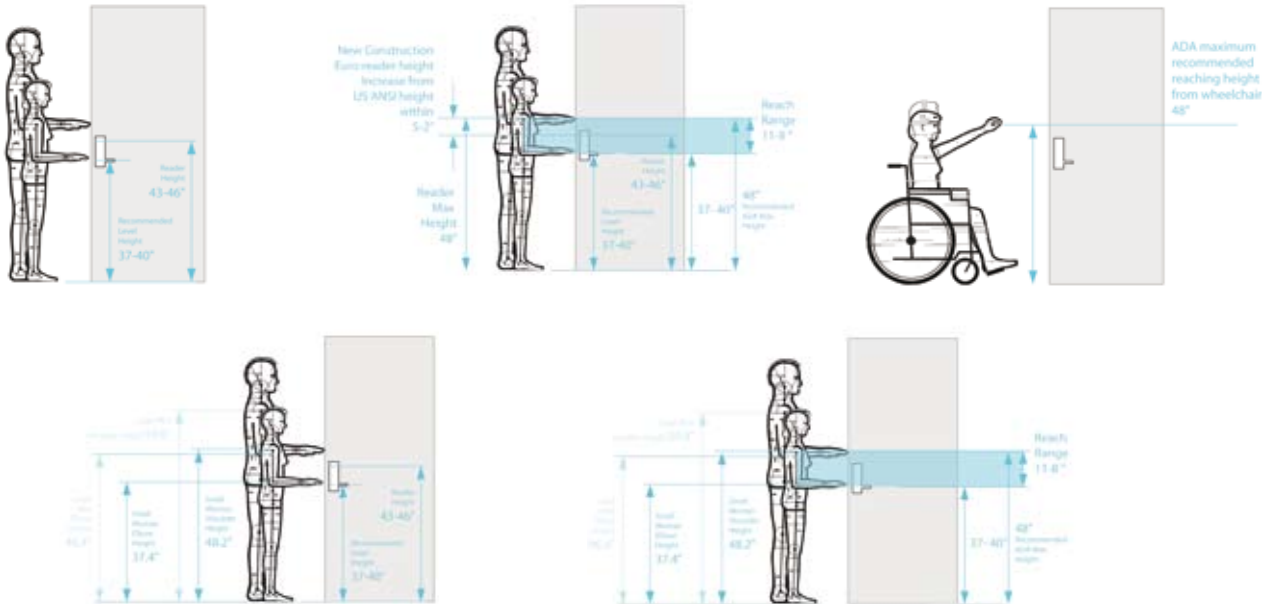

Research, Human Factors, Ergonomics & Ease of Use

Signature Series by VingCard is the result of a development process where the interaction of the product and the end-user is critical. Human factors and how the end-user interacts with the electronic lock were critical in the research in order to ensure that Signature Series by VingCard becomes the first truly ergonomic electronic lock in the market.

Too often, 'Ergonomics' have been about style, but it is much about design comfort for the end user.

Bresslergroup's advanced expertise in ergonomics and human factors helped identify the right location and height range of the reader and handle allowing to best accommodate the largest population of potential users. Signature Series by VingCard has been designed with the end-user, human factors and ergonomics in mind. It ensures an intuitive use and comfort level both for your guests and your staff.

research
ease of use



Design & Flexibility

It is understood among hoteliers, architects and interior designers that the hotel corridor is the introduction to the room, and that electronic locks have provided very few aesthetic alternatives.

Finding the most relevant and compelling design options thus required significant understanding of global hospitality design trends. Careful analysis of different hotel environments and styles around the world suggested that flexibility in design options was the key to success.

Signature Series by VingCard was especially designed with both new construction and major hotel renovations in mind to fulfill the desire for design continuity for hotel corridors, guestrooms and other hotel areas.

design
flexibility



Reliability & Security

Our commitment and strength is to offer the highest reliable security for both your hotel and your guests. Through experience, knowledge and modern technology, VingCard has continued to deliver just that in over 25 years.

Signature by VingCard delivers the same security and reliability that VingCard is known for worldwide, wrapped in a flexible and powerful operating system.

When security counts, you can count on VingCard.

reliable security
reliable security



Functionality

Signature Series by VingCard is fully equipped with all the features and system capabilities that have made VingCard the favorite choice when security counts in the hospitality industry.

Signature Series by VingCard offers your property and guests the highest flexibility and security regardless if you choose our magnetic stripe, combo (magnetic stripe and smart card) or the latest contact less RFID technology. VingCard electronic hardware and technology is designed to allow future upgrades and therefore make your investment last.

VingCard operating systems are feature-rich, easy to use by your staff, and easy to interface with any PMS and POS, Hotel Kiosk and other hotel systems.

functionality
functionality

Signature by VingCard

Design Your Security

Where the design integrity of the property is top priority, there is a desire for the necessary hardware to blend into the design, becoming virtually invisible to the end-user. Signature by VingCard is design conscious and appeals to the most sophisticated styles in the hotels worldwide.

'Signature Trend' by VingCard has been designed in order to respond to the vast range of contemporary hotel environments, making sure the lock blends perfectly with the rest of the property. For the more traditional and decorative styles, you will find 'Signature Décor' by VingCard to be the right choice.



Signature Trend by VingCard

'Signature Trend' by VingCard is especially suited for contemporary and modern hotel environments. It enhances the overall image of the corridor with the slim and discreet bezel which perfectly blends into the door, creating a pleasing and restrained image.

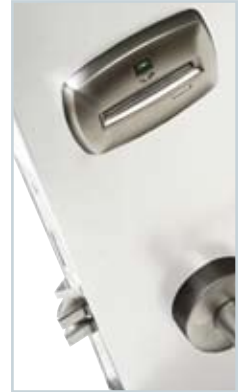

Signature Décor by VingCard

'Signature Décor' by VingCard has been designed with the classic and decorative hotel styles in mind. With its elegant curved bezel, Décor provides an exclusive image with the ambience of a classic and decorative style, enriching the overall atmosphere.

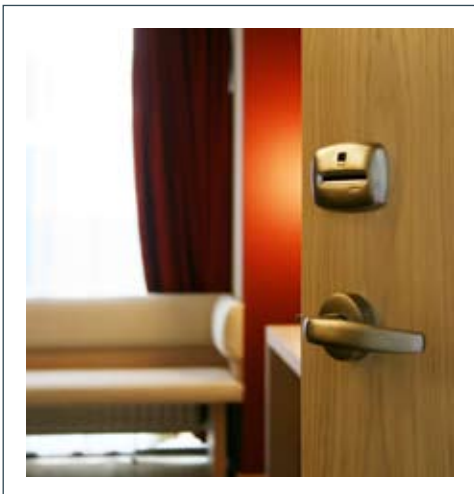
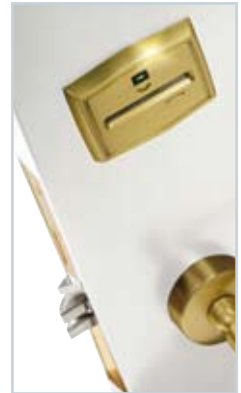

Features

- Flash RAM memory.
- 600 event audit trail.
- Optional Dual reader (mag/smart).
- Motorized lockcases with locking mechanism located in the lockcase (ie. no clutch in escutcheons).
- No accessible parts from the outside (i.e. no set screws on handles etc).
- High security heavy duty mortise lockcase available in ANSI or EURO versions with a 3-point anti friction steel latch and case hardened full 1- inch throw (ANSI) deadbolt.
- The lock is designed to ANSI grade 1 standards.
- Panic release - the deadbolt and latch are automatically retracted by the inside handle for easy egress in emergency situations.

Signature Standard Range - Bezels & Handles

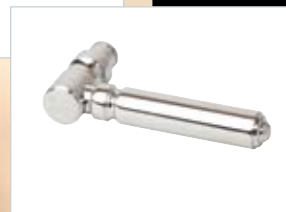
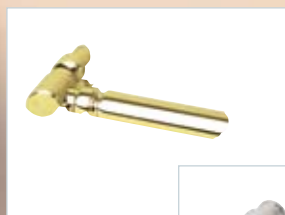

Gothic

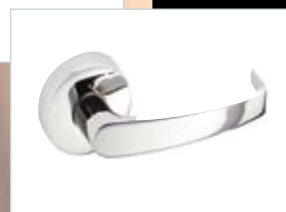
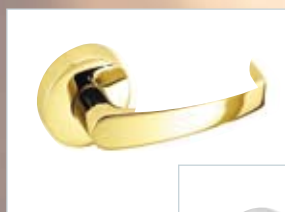

ANSI

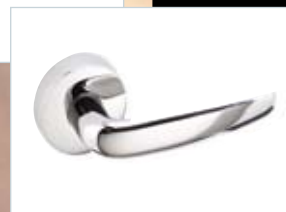
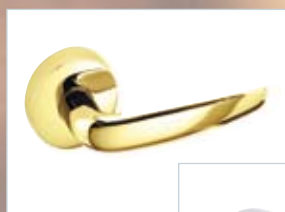

Straight

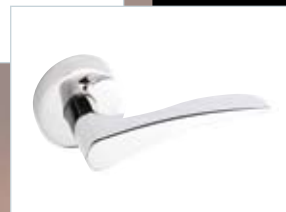
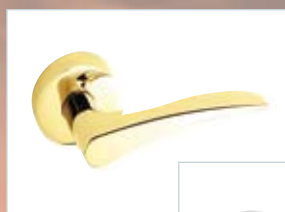

Wing



Trend



Décor

Signature RFID by VingCard

Get More with Contact Less

Signature RFID by VingCard, is the new contact less (Radio Frequency Identification (RFID) electronic lock designed to give you **More** Guest Satisfaction, Security, Adaptibility and Selection. Signature RFID technology offers the most flexible platform, compatible with all the main ISO standards, including NFC technology for the new generation of cell phones, giving you **Less** guess-work in terms of selecting the right technology standard.



RFID, contact less technology

Signature RFID by VingCard offers the latest Radio Frequency Identification (RFID) technology with the most flexible platform for future applications:

- 13,56MHz technology
- Compatible with following standards:

ISO 14.443 A (MIFARE)
 ISO 14.443 B
 ISO 15.693



- Compatible with Near Field Communication (NFC):
 (NFC technology enables RFID communication between our electronic locks with NFC-ready last generation cell phones).



Guests can receive the booking confirmation, an encrypted room key and room number to their cell phone by SMS prior to their arrival, thus no need to check in at front desk.

RFID carriers

A wide range of RFID (contact less) carriers

VingCard offers a wide range of RFID carriers that are especially designed for different applications (for your guests, for your staff or for your VIP guests) and gives you the opportunity to enhance your guests' experience at your hotel.

Typical Hotel application:

Guests: Low cost guest keycards.
 Staff: Long lasting staff keycards.
 VIP guests: Keyfobs and NFC cell phones.

Typical Resort & spa application:

Guests: Wristbands.
 Staff: Long lasting staff keycards.
 VIP guests: Wristbands, keyfobs or NFC cell phones.

future
 technology today

Signature RFID Carriers



Low cost guest keycards



Long lasting staff keycards



Keyfobs

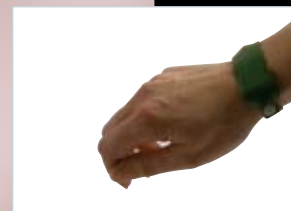

Wristbands



NFC Cell phone

Benefits & Features



Benefits:

- More **Guest Satisfaction**: Unmatched ease of use for guests of all ages. No need to insert the keycard, more intuitive.
- More **Security**: anti-cloning technology for all guest and staff cards. Unlike Mag-stripe whose keycards can be cloned, RFID technology allows powerful anti-cloning solution.
- More **Adaptability**: RFID keycards and carriers adapt to any hotel style: You can choose from low cost guest cards, long lasting staff cards, wristbands and keyfobs to perfectly match different hotel types: Business, Resort, Spa, All-inclusive.
- More **Information and Control**: Signature RFID electronic lock can write back information on staff RFID keycards for better information and management: Staff card audit trail, low battery status, cylinder tamper alarm.
- More **Integration**: You can integrate and interface Signature RFID keycards with other applications at your hotel (loyalty programs, vendor payment, etc).
- More **Exclusivity**: Provide a new experience for your customers and enhance the image of your hotel
- More **Robustness**: Signature RFID electronic lock components are sealed and provide better performance for outdoor use.
- More **Selection**: Provides access today to next generation technologies, including NFC-cell phone
- And **Less** guess-work out of selecting the right technology. Signature RFID by VingCard offers 4 technology standards in 1 electronic lock.

Features:

- Anti-cloning technology.
- Write-back, the RFID lock is able to write on to the RFID staff keycards (staff audit trail, auto card cancellation, cylinder tamper alarm, service diagnosis, read-out cards and more).
- RFID cards are ready to integrate other multi applications.
- Stand alone electronic lock with RFID technology. It is no longer needed to insert the keycard, which improves the ease of use for your guests.
- Flexibility to work with many different carriers. It can work with: low cost guest keycards, standard keycards, staff keycards, wristbands, keyfobs and NFC cell phones.
- Greater flexibility to personalize the experience of your customers and enhance the image of your hotel.
- Sealed components. Better performance in outdoor applications.
- Increased protection of the reader against vandalism.

future
technology today

Anti-Cloning Technology

Anti-cloning technology for all guest and staff keycards: allows powerful anti-clone solutions.

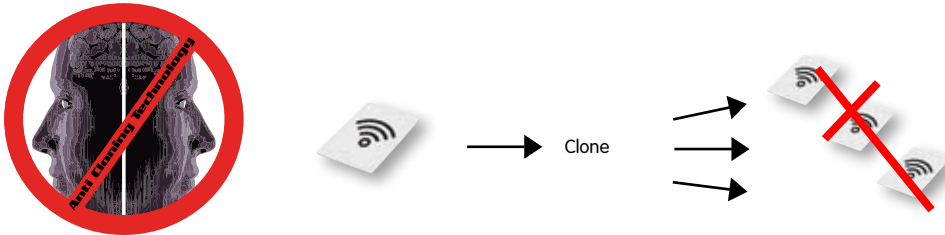

Quick path from standard Signature to RFID reader technology

Upgrade from Signature by VingCard mag stripe or combo technology reader to RFID technology by replacing the reader unit and escutcheon only.

- 3-5 minute operation.
- No disturbance or inconvenience for your guests.
- No need to replace the lockcase or handles.
- No drilling required.
- No downtime room availability.





DESIGNERS' COLLECTION

Optional Designers' Collection Signature- & Signature RFID by VingCard

VingCard has partnered with the following renowned designers through the famous Italian handle crafter Valli&Valli: Norman Foster and Partners, Yoshimi Kono, Gustav Peichl, Antonio Citterio, Gregotti Associati, Richard Meier, Sottsass Associati, Taller Design Ricardo Bofill, Massimiliano and Doriana Fuksas and Piano Design Workshop.

Because your hotel requires the most exclusive and luxury touch, and you want to offer a personal and unique experience to your guests, Signature Series by VingCard has created an optional Designers' Collection in order to offer you the most extensive and exclusive designer handles for electronic locks today.

**designer handles
designer handles**



DESIGNERS' COLLECTION



In partnership with





Designers



Taller Design Ricardo Bofill

The design of this handle lies particularly in the joint between the pin element and the handle itself, a joint which is inspired by the structural joining of metallic profiles, with the object of harmonizing all of the component elements. It is a simple and rigorous joining which confers the robustness necessary to this handle, an object submitted to such frequent use (*).



RB Novantacinque

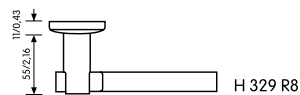
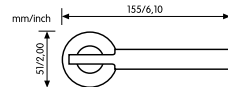

H 329 R8

Massimilano and Doriana Fuksas



MDF Duemiladue

I always do my projects. Without my drawings, my sketches, my paintings we do not go on. I go through my buildings before I build them. I dream my staircase, I go in night and daytime. It is a vision (*).

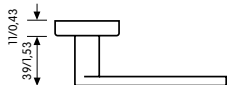
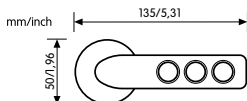

H 347 R8



Foster and Partners

The handle of a door could be linked to architecture in miniature. In another sense, it is an important part of the furniture in a building, literally one of the few points of physical contact. Source of inspiration was the world of pocket-knives. The blades with their mechanism are really like the middle of a sandwich, and they can be packaged in between moulded grips of a variety of materials. The choice is extensive and determines the appearance and quality of the end product (*).



NF Novantotto

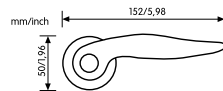

H 334 R8





Sottsass Associati

Our handles in their essential simplicity make a clear and strong statement in door design. They respect the ergonomics but, at the same time, they bring to the design of an interior, a “design” element that is immediately recognizable. Our proposal goes in the direction of accentuating to the utmost the essentials of design and supplying to architects and interior designers a product with strong characteristic features, which is, substantially, unique in its kind (*).



Quattro S



S Novanta

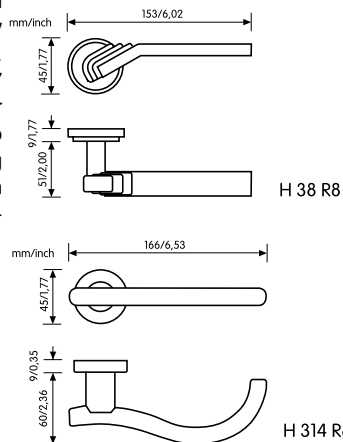

Yoshimi Kono



YK Duemila

President of Kono Designs, a New York City based design firm. He was previously at Vignelli Associates working as a product, graphic and interior designer. He has worked on a wide range of project including showrooms for Artemide and Poltrona Frau; product, packaging and retail design (*).

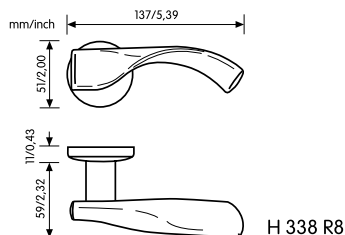

(*) For finishes, please see page 24.

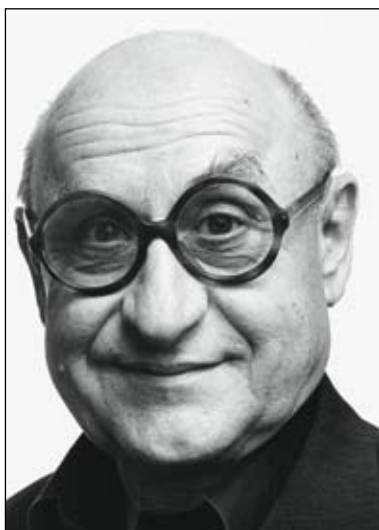

Gustav Peichl

Anyone who goes inside a building, either to live or to visit it, is influenced by the shapes, the materials and the colours. This happens also for door handles and window pulls. A handle must operate smoothly, must have a pleasing appearance and especially must have tactile qualities when it is touched. Each handle must radiate sensuality by sight and by touch (*).



GP Novantotto

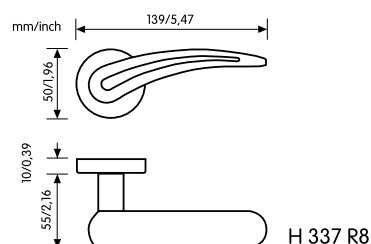

Antonio Citterio



AC Novantuno

My work on handles involves the redesign of classic models studying the small details and new proportions which then become the characteristic elements (*).

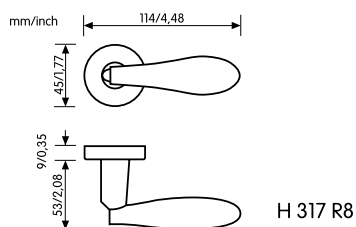
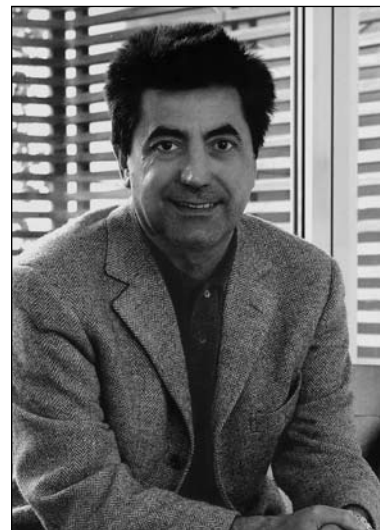



Gregotti Associati

Their work is expressed through architectural projects on a large scale and in general and detailed urban plans commissioned especially by public administrations as well as through reconstruction, interior projects, fittings and graphic planning, in coordinated images and designs commissioned by private individuals and industrial companies (*).



Otto G

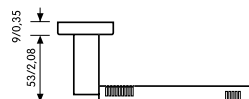
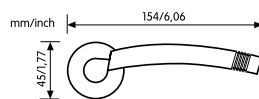

H 33 R8

Richard Meier



RM Novantotto

Extending the language of form that has defined Richard architecture, the RM Novantotto series fuses curves, rectangles and squares into hardware designed complement and enhance a variety of environments. The visual interaction of circle and rectangle mediates between the form of the hardware and the door itself, activating the whole in subtle ways (*).

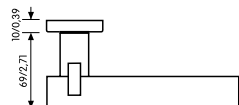
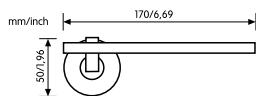

H 335 R8



(*) For finishes, please see page 24.



Piano Design Workshops

There is no gesture that is repeated with greater intention and there is no object of our daily life which requires more participation; or one on which our mood is so much projected. A door handle opens up on what is going to occur and it closes on that which has already happened (*).



P Novantotto

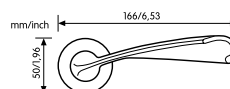

H 333 R8

(*) Design Valli Workshop



H123

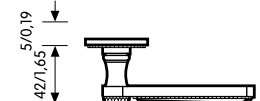
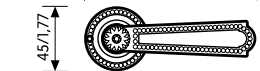

H 123 R8



H120

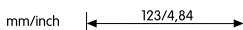

H 120 R8



K1160

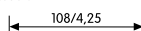

K 1160 R8



Design Continuity

The designers' collection handles are also available for bathroom, passage doors and other areas of your property.



Signature by VingCard - Standard Range

Finishes & Dimensions

Finishes

Offering one of the industry's widest choice of style, finish and handle combinations, Signature by VingCard can be configured to truly match the design of any property. All the different handles from the Designers' Collection are also available in the below finishes (Please note that all pictures in this brochure may differ from the actual finish).

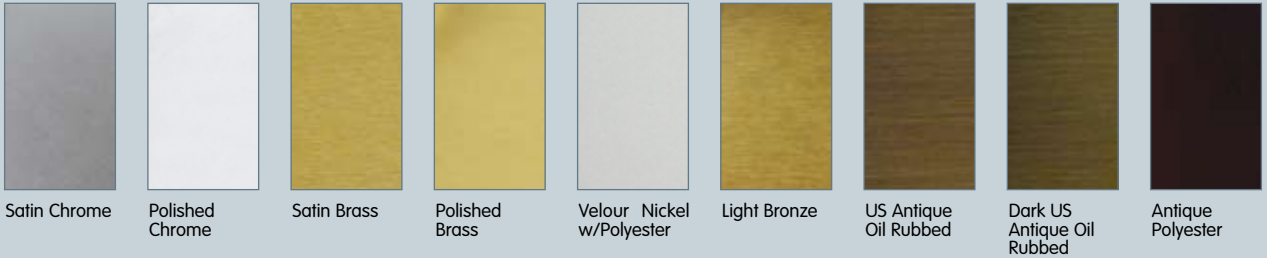

Signature standard dimensions

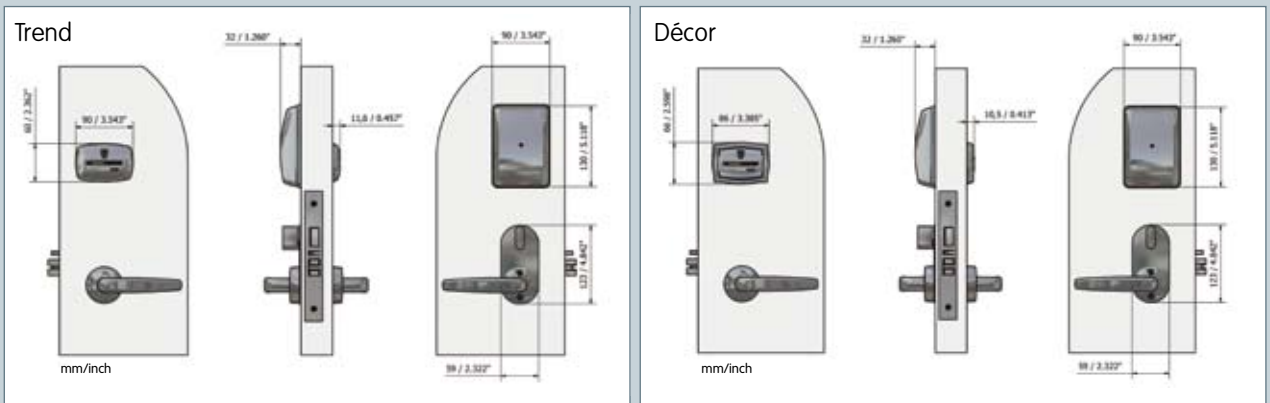

Signature RFID by VingCard

Colors & Dimensions

Color options

The RFID reader is available in Black as standard finish. In addition 4 optional colors are available: Red, Orange, Green and Blue.



Dimensions

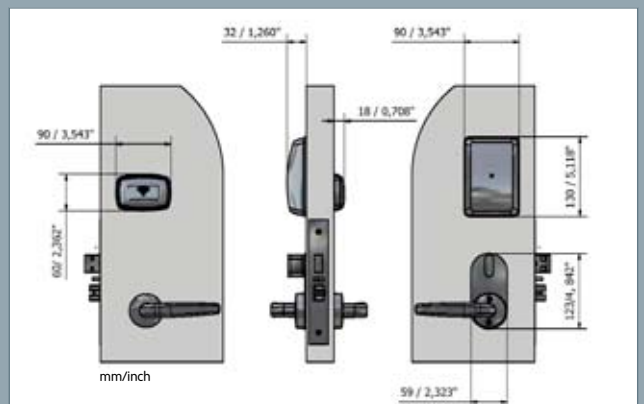

finishes
dimensions

Optional PVD finish (Physical Vapour Deposition) - for extreme conditions:

VingCard offers an exclusive PVD coated finish that protects the lock finish from corrosion, UV Beams, Salt, extreme weather conditions, aggressive cleaning products and more. PVD not only maintains the finish of the lock for longer, it is also covered by a 10 year warranty⁽¹⁾.



The PVD finish is available as an optional feature for Signature locks⁽²⁾ in the following finishes only: Satin Chrome/Brass and Polished Chrome/Brass.

⁽¹⁾Special terms and conditions apply to the PVD 10 years warranty program.
⁽²⁾PVD finish not available for Signature Décor or Gothic handle.

Lock Specifications & Options

Lockcases



ANSI lockcase



US ANSI lockcase



EURO lockcase



AUS lockcase



JPN lockcase

Automatic Deadbolt option

Auto deadbolt option where both the latch and deadbolt lock the door independently from each other.

Emergency Cylinder option

Signature Series by VingCard may also be supplied with an optional mechanical override cylinder, widely recognized as the finest in the industry.

- Use of mechanical Key Override is registered in the lock memory for audit trail.
- Mechanical cylinder can be either visible or not visible.
- The high quality cylinders offer superior pick resistant through its 7 pin high security profiles and anti pick drivers.
- In addition the cylinders are carefully constructed with a narrow channel paracentric keyway to maximize security.
- Unique special security bracket for added security.
- Emergency cylinder is available in Satin Chrome, Polished Chrome, Satin Brass and Black Matt finishes.
- 3 times recodable cylinder.



Battery Cover options

- Signature Series comes with a special high-resistant Polymer Battery Cover.
- Battery Cover can optionally be upgraded to match the rest of the lock finish.
- Signature Designers' Collection battery cover always matches the finish of the rest of the electronic lock.





System & Software

VISION by VingCard, an ideal combination of power and flexibility

VISION by VingCard is a full-featured, functionally rich access control system with the power and flexibility to meet the operating needs of any hotel - both now and in the future.

Imagine a locking system powerful enough to allow you to design a locking plan that fits exactly to your property's needs and operations, but yet dynamic enough to allow easy change and modifications when needed. A locking system which is intuitive to understand and use, but at the same time so feature rich and advanced that it includes all the small details which makes all the difference in day to day hotel operations, guest handling and security management at your property.

VISION is a result of more than 25 years of experience in hotel security, and a wealth of accumulated knowledge of what is important for hotels. Beside the basic requirements found in most locking systems, you will find a depth in features and attention to detail that might open up a new world including:

- Powerful SQL client server database technology for stable, high security operations and effective back up/restoring-options.
- True TCP/IP network capabilities. Encoders can be connected directly to the hotel's own LAN and shared between workstations.
- Flexible PMS & POS interface options. Choose between serial, TCP/IP and direct DLL integration.
- Windows® software platform.
- Supports both magnetic stripe-, dual magnetic stripe cards, smart card, contact less RFID keycards and carriers.
- Compatible with Automatic Check-in Kiosks.
- Manages up to 8 different weekly time/shift tables. Customize every day of the week in 30 minutes increments.
- Manages up to 53 different common door definitions.
- And many more...

vision
by VingCard®

Signature RFID by VingCard is only compatible with VISION by VingCard, Signature by VingCard is in addition compatible with 2800 by VingCard System.

system & software
system & software





Signature
by VingCard®

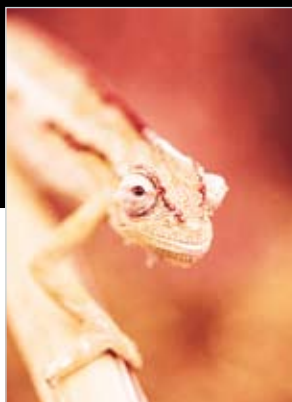

Signature
by VingCard®

For more information, please contact:



Europe/Middle East/Africa:
E-mail: emea@vcegroup.com
Phone: +47 69 24 51 00

North America:
E-mail: noram@vcegroup.com
Phone: +1 972 907 2273

Asia/Pacific:
E-mail: aspac@vcegroup.com
Phone: +65 6748 7227

Latin America:
E-mail: lam@vcegroup.com
Phone: +52 55 36 40 12 14

VingCard Elsafe • info@vcegroup.com • www.vingcard.com • www.elsafe.com

Specifications may change without notice.